

Version
01.00July
2003

Universal Radio Communication Tester R&S[®] CMU300

The base station tester for current and future mobile radio networks

- ◆ Extremely high-speed testing
- ◆ Highly accurate measurements
- ◆ Modular future-proof design
- ◆ Comprehensive spectrum analyzer and signal generator

Now with WCDMA support

The R&S CMU300 – a new generation in base station testing

Rohde & Schwarz milestones in digital testing

1990 R&S CMTA94 The first test set for GSM transmitter and receiver testing.

1991 R&S CRTS02/04 Signalling tester for GSM mobile and base stations.

1992 R&S FTA Sole supplier of the GSM 900 system simulator for conformance testing of mobiles.

1993 R&S ITA Sole supplier of GSM 900 interim conformance test system, upgradable to GSM 1800.

1994 R&S CMD55/57 The world's first compact digital radiocommunication tester for GSM mobiles and base stations.

1996 R&S CRTP/C02 Approved as standalone tester for conformance testing of GSM 900/1800 phase II mobiles.

1997 R&S TS8915 Supplier of the first conformance test system for GSM 1900.

1997 R&S CMD65 The world's first compact digital radiocommunication tester for GSM 900/1800/1900 and DECT.

1999 R&S CMU200 THE cellphone tester for current and future mobile radio networks.

2000 R&S CMU300 Base station tester for current and future mobile radio networks.

Rohde & Schwarz has always been at the forefront of mobile radio technology. For 70 years now we are developing solutions for our customers.

The R&S CMU300 carries on this tradition. As a high-end communication tester platform for base stations it completes the Rohde & Schwarz product portfolio.

The R&S CMU300 reflects the long-standing expertise Rohde & Schwarz has gained in the world of mobile communication and base station testing in different fields such as production, R&D, commissioning, system test, service and maintenance.

The R&S CMU300 is designed to provide a flexible platform for customized solutions and testing with maximum speed, top accuracy and optimum repeatability. Its home is the world of digital mobile networks of generations 2, 2.5 and 3.

Ask your local Rohde & Schwarz representative for a demonstration and help to find out about your requirements.



The R&S CMU300 can handle a wide range of applications, but is primarily optimized for the high accuracy and speed demanded in an ever more quality-conscious manufacturing process. The picture shows the front panel for desktop use.

Key strengths

The Radio Communication Tester R&S CMU300 ensures premium cost effectiveness through a variety of features, with extremely fast measurement speed and very high accuracy being the two most important ones. In addition, the secondary remote addressing of the unit's modular architecture makes for intelligent and autonomous processing of complete measurement tasks and fast control program design.

Greatest accuracy

In a production environment the unit's high accuracy allows DUTs (devices under test) to be tested for optimal mobile network performance. In the lab, the R&S CMU300 enables the development engineer to replace conventional, dedicated premium-quality instruments more often than any other radio communication tester and save desktop space at the same time. High-precision measurement correction over the whole frequency and dynamic range as well as compensation for temperature effects in realtime are critical factors for achieving the R&S CMU300's excellent accuracy.

The new, globally standardized, Rohde&Schwarz calibration system can check the R&S CMU300's accuracy in a service center close to you or, volume permitting, on your premises. A worldwide network of these standardized automatic calibration systems has been implemented in our service centers. Highly accurate and repeatable calibration can be performed wherever you are. Your local Rohde&Schwarz representative offers customized service contracts for the unit.

Greatest speed

The high processing speed is due to extensive use of ProbeDSP™ technology, parallel measurements and innovative remote command processing. These three aspects of the performance of the R&S CMU300 are explained in more detail below.

ProbeDSP™ technology

The modular architecture relies on decentralized ProbeDSP™ processing coordinated by a powerful central processor. Like an oscilloscope probe, DSPs dedicated to a specific local data acquisition and evaluation workload help to keep subsystem performance at an uncompromised maximum even if additional modules are fitted to the R&S CMU300 mainframe.

Innovative remote processing

The novel secondary addressing mode can address similar functions of each of the R&S CMU300's subsystems (different mobile radio standards) in an almost identical way. Using this type of addressing, new remote test sequences can be programmed by a simple cut and paste operation followed by editing specific commands to adapt the control program to the new application. Secondary addressing is fully SCPI-compliant, which means that a subsystem address, for example "GSM 1800", can be replaced by a string denoting a different subsystem (another mobile radio standard).

Key advantages of the R&S CMU300

Speed

- ◆ Single measurement up to 10 times faster than with the previous generation of instruments

Accuracy

- ◆ Three times more accurate than the previous generation of instruments with excellent repeatability

Modularity

- ◆ Modular hardware and software concept providing easy extension to enhanced functionality

Bullet-proof

- ◆ Low component count, low power consumption, and effective heat conduction for unparalleled reliability

Future-proof

- ◆ Easy migration to future standards

Greatest reliability

The keys to the high reliability of the R&S CMU300 are the low power intake and the innovative cooling concept. Less power means less heat. Power consumption is way below 200 W due to specially selected low-power components, the minimum component count concept, plus low voltage design wherever possible.

The R&S CMU300 employs an ultra-effective heat management between housings and individual components as well as between heat sinks and air flow. Independent cooling cycles for the front module controller, the power supply unit and the RF frontend add up to an optimized cooling system.

Base unit

As the R&S CMU300 has a modular architecture, the base unit comes without any network- or standard-specific hardware and software. The base unit can be used for testing the general parameters of RF modules at early production stages. Constituent parts of the R&S CMU300 base unit are the RF generator and RF analyzer, which are completed by a versatile network-independent time domain menu and a comprehensive spectrum analyzer.

Besides the convenient operational concept, the spectrum analyzer stands out for a continuous frequency range (10 MHz to 2.7 GHz) and several selectable resolution bandwidths. The zero span mode represents a separate operation group with sophisticated trigger and timing functions (pre-trigger, delay, time-base, slope).

The RF switching matrix is one of the R&S CMU300's highlights. It is located directly behind the connectors and yields a superior VSWR of better than 1:1.2. The instrument can be easily adjusted to the DUT by means of four flexible N connectors. Two connectors (RF1, RF2) are configurable as duplex RF interfaces. One connector is for high power base stations up to +47 dBm, and the other one is for micro base stations with a maximum output power of +33 dBm. In addition, the instrument is equipped with a high power output (RF3 OUT; up to +13 dBm) and a sensitive input (RF4 IN; -80 dBm to 0 dBm). The power of incoming RF signals can thus be analyzed in the range from +47 dBm down to -80 dBm. Signals from -130 dBm up to +13 dBm can be generated for receiver tests.

The rear-panel reference input and output is the prerequisite for minimizing systematic frequency errors during measurement. It is fitted as standard. Besides the IEEE and RS-232-C interface the base unit is equipped with two PCMCIA slots.

Operation

The instrument can be operated either manually or via the IEC/IEEE bus. The hierarchical menu structures in conventional communication testers have been replaced by context-sensitive selection, entry and configuration pop-up menus, which results in a uniquely flat menu structure.

Owing to the high resolution of the extremely bright high-contrast TFT display even the finest details can be displayed.

To increase speed, measurements that are not required can be switched off, which frees resources for the measurement you want to focus on.

Advanced operational ergonomics have been incorporated into a most compact package. Even with the rackmount kit, the R&S CMU300 does not exceed four height units.

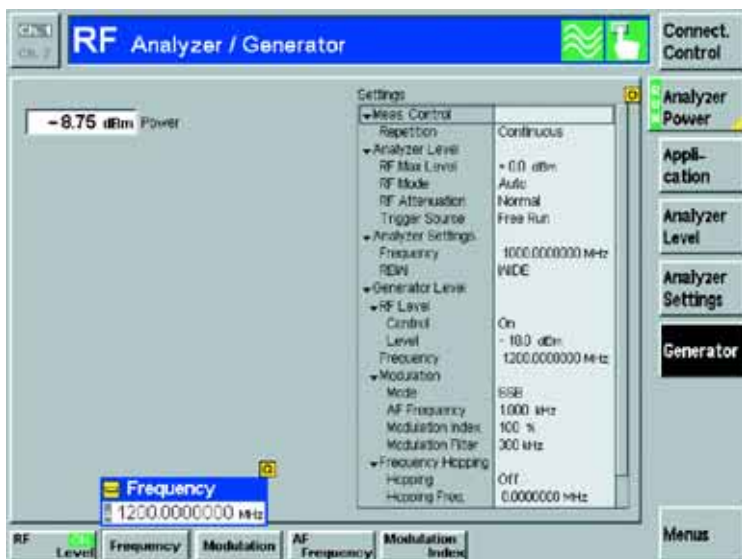

The base unit incorporates generic RF analyzer / generator functions

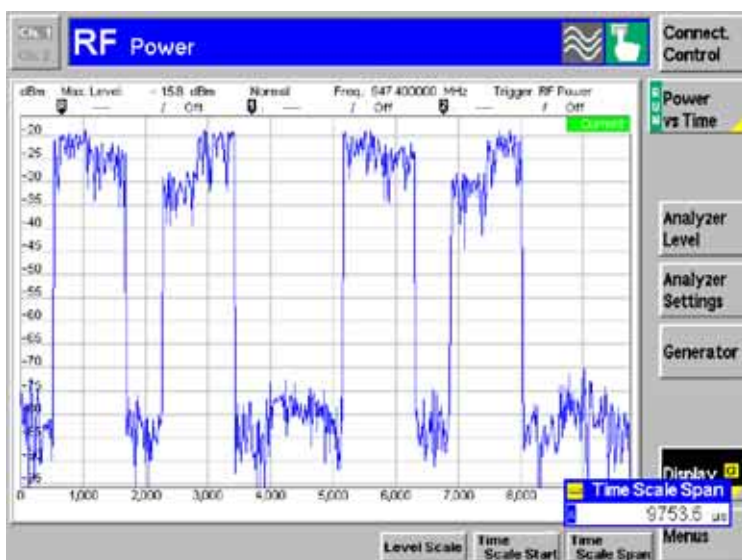

The zero span mode of the spectrum analyzer is optimized for all kinds of RF signals



The spectrum analyzer provides several marker functions for a comprehensive investigation of the signal applied

GSM/EDGE test modes

Tailor-made with options

The basic version of the R&S CMU300 already offers signal generator and spectrum analyzer functionality. It is converted into a GSM radiocommunication tester (transmitter and receiver measurements for GMSK modulation) by adding the R&S CMU-B21 hardware option (signalling unit) and at least one of the five GSM software options.

- ◆ GSM 400 (R&S CMU-K30)
- ◆ GSM 850 (R&S CMU-K34)
- ◆ GSM 900 (R&S CMU-K31)
- ◆ GSM 1800 (R&S CMU-K32)
- ◆ GSM 1900 (R&S CMU-K33)

In this way – as an essential feature – all GPRS channel coders are available in the R&S CMU300. The GSM functionalities can be extended to EDGE (TX and RX test functionality) by means of the R&S CMU-K41 software option, which also adds EGPRS channel coders. The R&S CMU-K39 software option allows link setup using the standard call procedures MOC/MTC (mobile originated/terminated call). The available hardware options include a highly accurate, oven-controlled crystal (R&S CMU-B12) and an A_{bis} board (R&S CMU-B71). The latter is needed for BER tests where the bit pattern sent by the R&S CMU300 is returned to the R&S CMU300 via the A_{bis} interface.

Non-signalling mode

This mode is particularly suitable for testing RF boards/modules with little or no signalling activity. The measurement starts completely independently from external trigger signals or signalling information. As soon as RF power is applied to the input, the tester starts to sample the incoming RF signal. When the corresponding RF parameters are calculated

and displayed, the instrument is ready for the next measurement. All GSM/EDGE-specific TX measurements on signals with appropriate modulation scheme and midamble are available. In addition, the R&S CMU300 is able to generate signals with GSM/EDGE-specific midamble and modulation in the entire frequency range from 10 MHz to 2.7 GHz. The analyzer and generator functionalities are not linked, i.e. any channel spacing between uplink and downlink signals is possible.

Signalling mode

The signalling mode is provided for testing modules or base stations supporting a certain level of signalling. In this mode, the tester operates synchronously to the BTS, i.e. it is synchronized to the TDMA frame structure, which is vital for receiver bit-error-rate measurement. All transmitter parameters can be tested separately for each timeslot. This function is necessary for testing base stations that support both GSM and EDGE. The ability to code / decode channels in realtime is the basis for synchronized measurements. The instrument can be synchronized to the base station in the following ways:

- ◆ If the BTS has a multiframe clock output, the signal can be used to trigger the R&S CMU300. An additional trigger line has to be taken into consideration. For BER tests and EDGE TX tests the 26 multiframe trigger is required.
- ◆ If only the RF connection is used, the tester can synchronize to the C0 carrier of the base station, just like a mobile phone. This simplifies the test setup. However, a CCH carrier including FCCH/SCH channels and system information 1 to 4 must be activated in the BTS before measuring the used traffic channel.

After successful synchronization there is permanent resynchronization to SACCH of TCH.

Call setup

In the signalling mode, the R&S CMU300 is able to provide a mobile simulation (optional) with mobile originated call (MOC), mobile terminated call (MTC) and location update procedures. This is necessary whenever the complete signalling of the BTS air interface is to be tested, the BTS is in slow frequency hopping (SFH) mode or the BTS measurement reports have to be checked. During location update, MOC and MTC, the layer 3 messages exchanged between the R&S CMU300 and the base station are shown on the TFT display. The IMEI and IMSI numbers of the simulated mobile (R&S CMU300) must be entered manually, no SIM card being used.

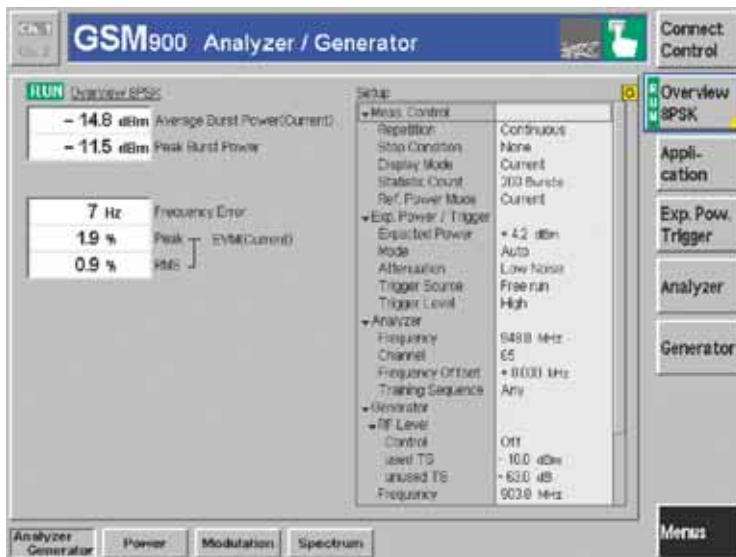

The non-signalling mode allows GMSK/8PSK signals to be generated and analyzed for RX/TX module testing; the hotkeys at the bottom of the screen give immediate access to specific measurements

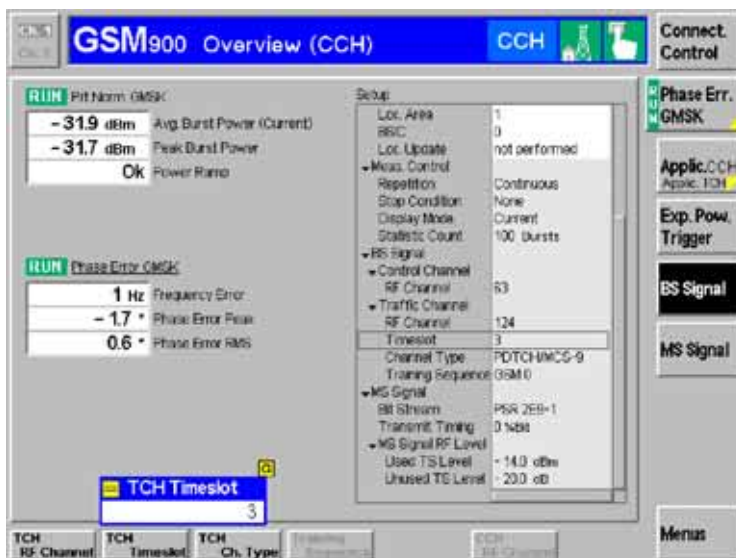

The signalling mode overview menu informs the user quickly and comprehensively about the BTS's TCH RF performance; timeslot selective measurements are possible

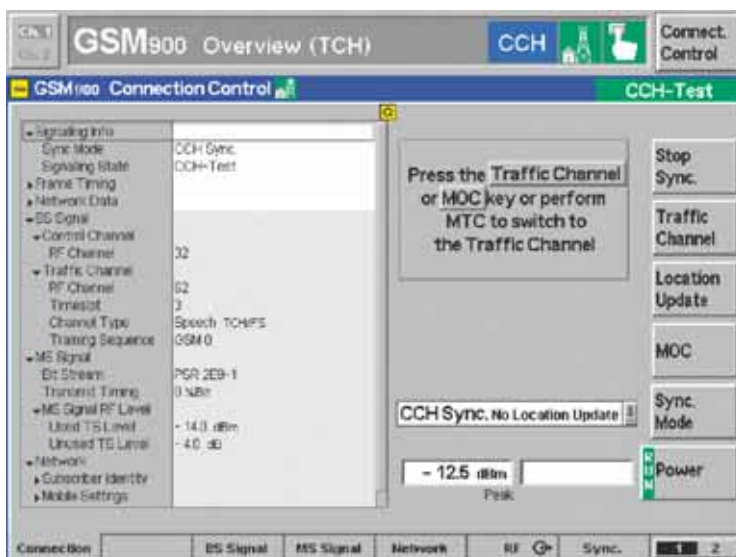

There are different possibilities for setting up the channel to be measured in the Connection Control pop-up menu

GSM/EDGE RX (BER) measurements

Principles

When it comes to receiver characteristics, the physical effects appear in the DUT itself, so no direct measurement is possible. The GSM standardization committees therefore defined test methods for measuring the receiver characteristics of GSM/EDGE BTSs. According to these test methods there are two logical reference points inside the BTS where the receiver quality must be defined. These reference points are located behind the demodulator and behind the channel decoder. The basic principle of bit error ratio (BER) testing is simple. The R&S CMU300 sends a data stream to the BTS, which then sends it back to the tester (loop); i.e. the signal to be analyzed is forwarded from the reference point inside the BTS to the external BER analyzer by means of different loops. The R&S CMU300 compares the sent and received uncoded data bits to determine the number of bit errors. Two essentially different loops are used:

- ◆ The BTS is set to close its RF loop directly after the logical reference points. The received data is returned on the RF downlink path. The benefit of this measurement principle is that no extra cabling is needed besides the "ordinary" RF connection. This approach is an easy way of testing the most important GSM/EDGE channel types.
- ◆ Using the A_{bis} loop the decoded signal is forwarded to the BER analyzer via the A_{bis} output of the BTS. This test path is often required when there is no possibility for loop activation inside the BTS.

Absolute receiver sensitivity

Based on realtime BER capability the user can directly vary the transmitter level during the test by means of numerical entry or the spinwheel. This is a fast and easy way to determine absolute receiver sensitivity.

Receiver stress test

For this application the R&S CMU300 provides different transmitter levels for the active timeslot and for the unused timeslots (dummy bursts). The receiver in the BTS can thus be subjected to unfavourable conditions in the unused timeslots.

Pseudo-random bit streams

The tester uses a choice of four true pseudo-random bit sequences for BER measurement. You will especially appreciate this feature if you have ever overlooked a faulty channel coder by using a fixed bit pattern, because a pseudo-random sequence is the only reliable means of detecting it. For transmitter measurements the BTS RF loop can also be kept closed outside BER measurements. This is a simple way of providing the transmitter signal modulated with pseudo-random bits required for spectrum and power measurements.

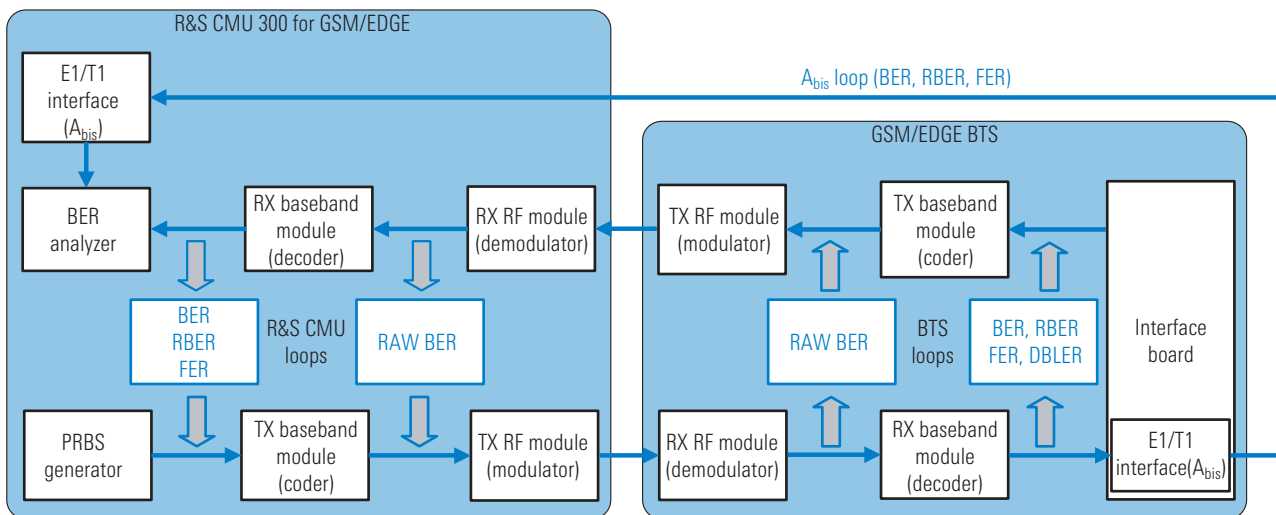

BER test environment

RAW BER test

In the burst by burst mode, the R&S CMU300 transmits only bits without error protection such as class II bits. The loop in the BTS under test has to be closed before channel decoding/coding, so raw bits are measured and the BER is evaluated on a burst by burst basis.

BER test of TCHs

Circuit-switched traffic channels can be tested in the BER or residual BER (RBER)/ frame erasure rate (FER) test modes. The instrument supports the RF loop and the A_{bis} loop (option R&S CMU-B71 required). A cyclic redundancy check (CRC) excludes bit errors on the return path (downlink) from the BTS to the R&S CMU300. Additionally, the instrument itself can be used as a loop on the U_m air interface, which means that it can loop back information from the RF downlink to the uplink including decoding/coding. The BER result indicates errors of class Ib/II bits. In the RBER/FER mode, the errors of class Ib/II bits of non-erroneous frames are calculated and furthermore, frames with erroneous class Ia bits are taken into account (FER).

BER test of PDTCHs

For packet-switched data traffic channels the bit error ratio test is modified in such a way that the BTS loops back the received data packets on a block by block basis (loop behind channel decoder required) and measures the BER and the data block error rate (DBLER). The test setup is similar to the one which is used on circuit-switched channels. The test is based on an RF connection, where one timeslot is permanently used on the uplink and downlink with packet-switched channel coding being active. No attach/detach functionality is required because no RLC/MAC layer is involved.

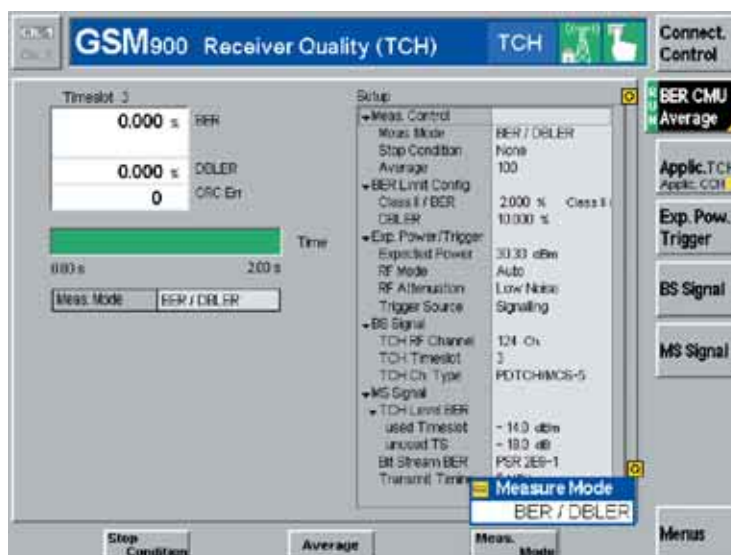

Receiver Quality (TCH) menu; RF loop; BER/DBLER mode

Overview of the R&S CMU300 BER test capabilities

Channel type	Possible tests	Supported BTS/BSC loops	Supported loops "inside" R&S CMU (R&SCMU300 as RF loop)	Channel setup procedure	Required options (in addition to R&S CMU-B21)	Comments
–	Burst by burst (RAW BER)	BTS loop demodulator/modulator	R&S CMU RAW BER loop	Forced channel setup without signalling	R&S CMU-K30 to -K34 (R&S CMU-K41 optional for 8PSK)	GMSK and 8PSK supported
TCH/FS TCH/HS TCH/FS	BER / RBER / FER	BTS (BSC) BER loop with channel decoding; (optional loop via A_{bis})	R&S CMU BER loop with channel decoding	Forced channel setup without call procedure (optional, MOC/MTC)	R&S CMU-K30 to -K34; (R&S CMU-B71 and R&S CMU-K39 optional)	–
TCH/F14.4 TCH/9.6 TCH/F4.8 TCH/H4.8 TCH/H2.4	BER	BTS (BSC) BER loop with channel decoding	R&S CMU BER loop with channel decoding	Forced channel setup without call procedure (optional MOC/MTC for full rate channels)	R&S CMU-K30 to -K34 (R&S CMU-K39 optional)	–
E-TCH/ F43.2 NT	BER	BTS (BSC) BER loop with channel decoding	R&S CMU BER loop with channel decoding	Forced channel setup without signalling	R&S CMU-K30 to -K34 and R&S CMU-K41	–
PDTCH-CS1 PDTCH-CS2 PDTCH-CS3 PDTCH-CS4	BER/ DBLER	BTS BER loop with channel decoding, without RLC MAC	R&S CMU BER/DBLER loop with channel decoding	Forced channel setup without signalling (one static TS active on up-/down-link)	R&S CMU-K30 to -K34	Special BTS test mode required
PDTCH-MCS1 PDTCH-MCS2 PDTCH-MCS3 PDTCH-MCS4 PDTCH-MCS5 PDTCH-MCS6 PDTCH-MCS7 PDTCH-MCS8 PDTCH-MCS9	BER/ DBLER	BTS BER loop with channel decoding, without RLC MAC	R&S CMU BER/DBLER loop with channel decoding	Forced channel setup without signalling (one static TS active on up-/down-link)	R&S CMU-K30 to -K34 and R&S CMU-K41	Special BTS test mode required

Additional functions for GSM/EDGE conformance tests

RACH test

The R&S CMU300 transmits a sequence of random access bursts on the random access channel (RACH) to the base station and analyzes the frame erasure rate (FER) of the immediate assignments that are returned by the base station controller (BSC). The number of bursts to be transmitted and the intervals between them can be varied. The test setup of the RACH test must reflect the conditions of the real network, i.e. the base transceiver station (BTS) must be controlled by the BSC or the BSC simulator.

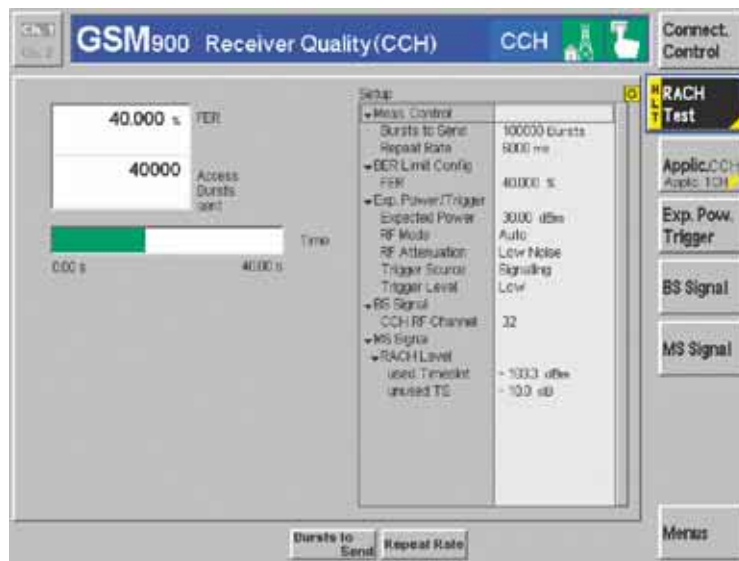

The FER is the ratio of the number of sent RACH bursts to the immediate assignments received

Applications

- ◆ Network stress tests for checking the maximum registration capacity
- ◆ Sensitivity measurements with reference to the RACH are thus possible

Test of signalling channels

For conformance tests, the R&S CMU300 provides the following uplink signalling channels modulated with PSR data (option R&S CMU-K38):

- ◆ FACCH/F
- ◆ SACCH
- ◆ SDCCH/4
- ◆ SDCCH/8

The PSR data must be evaluated in the BTS or its controller.

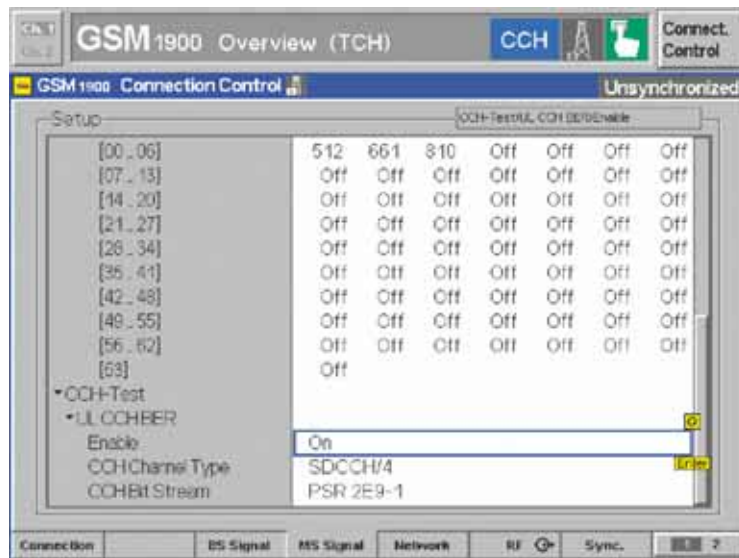

The uplink signalling channels can be activated via the GSM connection control menu

Test of base stations in the slow frequency hopping mode

If a base station supports the hopping mode, it must be tested in accordance with the 3GPP TS 51.021 base station specifications under hopping conditions. It must therefore be possible to set the instruments to the hopping mode. The R&S CMU300 provides the following options:

Activation by call

The tester synchronizes to the BCCH. The channel to be tested is activated via the standard MOC/MTC call procedures. The base station transmits the following parameters required for hopping:

- ◆ Mobile allocation index offset (MAIO)
- ◆ Hopping sequence list

On the basis of the current frame number, the R&S CMU300 starts hopping in accordance with the ETSI specifications.

Forced hopping

In contrast to the above, the parameters are manually entered directly into the tester. The traffic channel must be activated without a signalling procedure. The previously synchronized R&S CMU300 then starts hopping on the basis of the current frame number in accordance with ETSI specification TS 05.02.

GSM TX measurements

GMSK

Phase and frequency error

The actual phase of the signal received from the base station is recorded during the entire burst and stored. The transferred data is demodulated and the training sequence searched for. The middle of the training sequence (transition between bits 13 and 14) is used for time synchronization.

The complete data content of the burst is then mathematically modulated using an ideal modulator. The resulting ideal phase is compared with the measured phase. From the difference between the two quantities (the phase difference trajectory), a regression line is calculated using the mean square error method. The phase error is the difference between the phase difference trajectory and the regression line; it is calculated and plotted over the whole useful part of the burst. The average frequency error in the burst is equal to the derivative of the regression line with respect to time.

The R&S CMU300 evaluates the phase error with a resolution of 4 measured values per modulated bit, which corresponds to a sampling rate of approx. 1 MHz.

Spectrum measurements

The spectrum measurement determines the amount of energy that spills out of the designated radio channel when the base station transmits with predefined output power. The measurement is performed in the time domain mode, at a number of frequency points symmetrically distributed around the nominal frequency of the designated channel.



The power versus slot measurement simultaneously provides information about 8 power steps

Power measurements

The signal power received from the base station is displayed as a function of time (burst analysis) over one burst period. The measurement graph can be further processed to determine an average, minimum or maximum result as well as to calculate the average over the whole burst. In addition to the burst power measurement, a limit check with tolerances is performed. The displayed continuous measurement is derived from 668 equidistant measurement points with a $\frac{1}{4}$ bit spacing, covering a time range of $156 \frac{3}{4}$ bit.

In the signalling mode only, a second application is available – the power versus slot measurement. The power versus slot measurement determines the average burst power in all eight timeslots of a TDMA frame. The average is taken over a section of the useful part of the burst; it is not correlated to the training sequence. The result is displayed as eight bar graphs, one for each time slot of a single frame, which allows a very large number of bursts to be measured in extremely

short time. Therefore this application is suitable whenever the behaviour or the stability of the average burst power in consecutive timeslots is to be monitored. Another highlight of this measurement is the fact that power results are available almost in realtime. The power versus time measurement, however, returns the current, average, maximum and minimum value within a statistic cycle.

EDGE TX measurements

8PSK

8PSK/EDGE is another step towards increasing the mobile radio data rate. By using the available GSM frame structure, the gross data rate is three times that obtained with GMSK. The R&S CMU300 can already perform 8PSK on GSM bursts and analyze them owing to advanced measurement applications. Error vector magnitude and magnitude error have been added to the range of modulation measurements. New templates for power versus time measurements ensure compliance with the specifications, as do the modified tolerances for spectrum measurements. As with all measurements provided by the R&S CMU300, special attention has been given to achieving maximum measurement accuracy and speed for EDGE too. All measurement tolerances are set by default to GSM recommendation 11.21 but may of course be altered to suit individual needs.

Modulation analysis

For modulation analysis, the actual modulation vector of the signal received from the base station is measured over the complete burst and stored. The following non-redundant quantities are calculated on the basis of a comparison of this vector with the computed ideal signal vector:

- ◆ **Phase error**
The phase error is the difference between the phases of measured and the ideal signal vector.
- ◆ **Magnitude error**
The magnitude error is the difference between the magnitudes of the measured and the ideal signal vector.
- ◆ **Error vector magnitude (EVM)**
The EVM is the magnitude of the vector connecting the measured and the ideal signal vector. In contrast to the previous quantities, the EVM cannot be negative.

These three quantities are calculated as a function of time and displayed over the whole useful part of the burst (symbols 6 to 162), each of them in a separate graphical measurement menu. In addition, the peak and RMS values of all three quantities are calculated (over the whole display range or over the first ten symbols only) and displayed.

Finally, the modulation analysis provides the following scalar quantities:

- ◆ **95:th percentile**
Limit value below which 95% of the values of a measurement graph are located. The 95:th percentile of a measured quantity has the same unit as the quantity itself. The R&S CMU300 determines 95:th percentiles for EVM, magnitude error and phase error.
- ◆ **Origin offset**
The origin offset in the I/Q constellation diagram reflects a DC offset in the baseband signal. The origin offset corresponds to an RF carrier feed-through.
- ◆ **I/Q imbalance**
Amplitude difference between the in-phase (I) and the quadrature (Q) components of the measured signal, normalized and logarithmic. The I/ Q imbalance corresponds to an unwanted signal in the opposite sideband.
- ◆ **Frequency error**
Difference between the measured frequency and the expected frequency. For the tolerance check all three phase error graphs can be fitted into a tolerance template and checked.

Power measurements

The 8 PSK power versus time measurement results are similar to the GMSK measurement results. With 8PSK modulation the time axis is scaled in symbol points. 8PSK symbols and GMSK bits have the same transmission rate.

Owing to the characteristics of 8PSK modulation, the amplitude of the RF signal varies according to the data transmitted.

The average setting ensures that a correct reference power is used, the results being averaged, however, over an extended measurement time. In data-compensated mode, a known data sequence is used to correct the measured average power of the current burst and estimate the correct reference power.

The R&S CMU300 can be used to check the power ramps of up to 4 successive bursts for multislot applications. Measurements are performed in the signalling measurement mode and can automatically adapt the power ramp required in each burst to the type of modulation used (GMSK or 8PSK). This feature makes the instrument ideal for use in testing transmitters that must support both types of modulation.

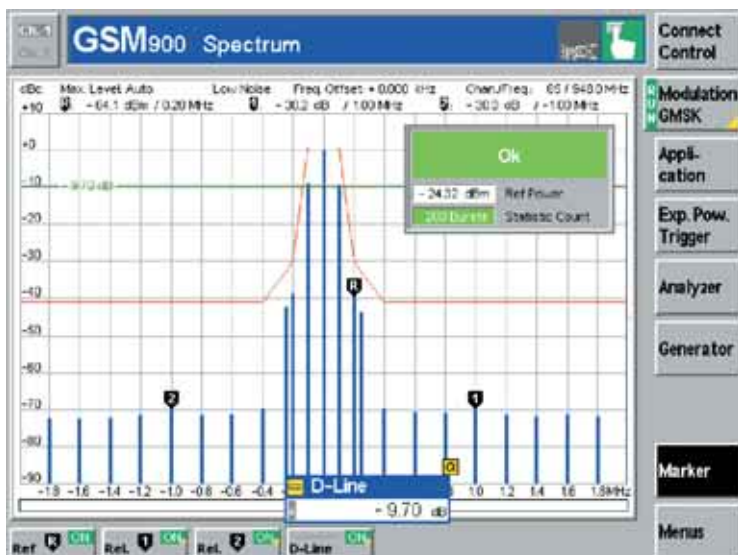

Different graphical functions (marker, limit line) are available for spectrum due to modulation measurement

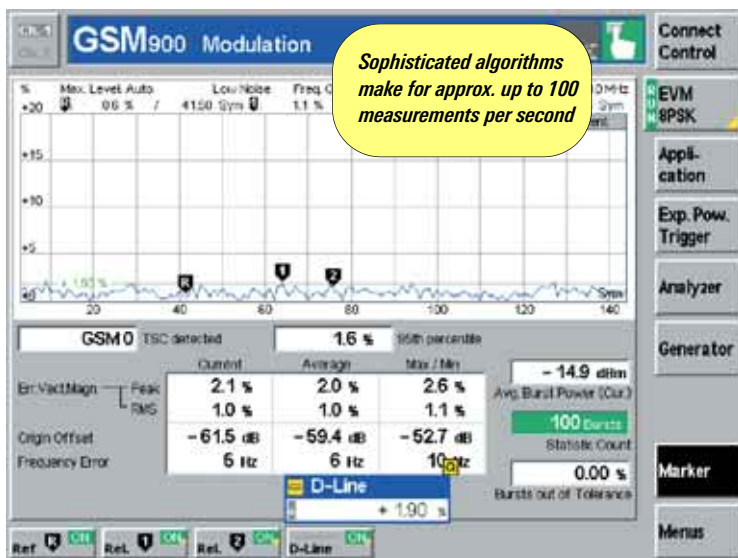

The Modulation Overview 8PSK menu selects all scalar modulation results to be displayed

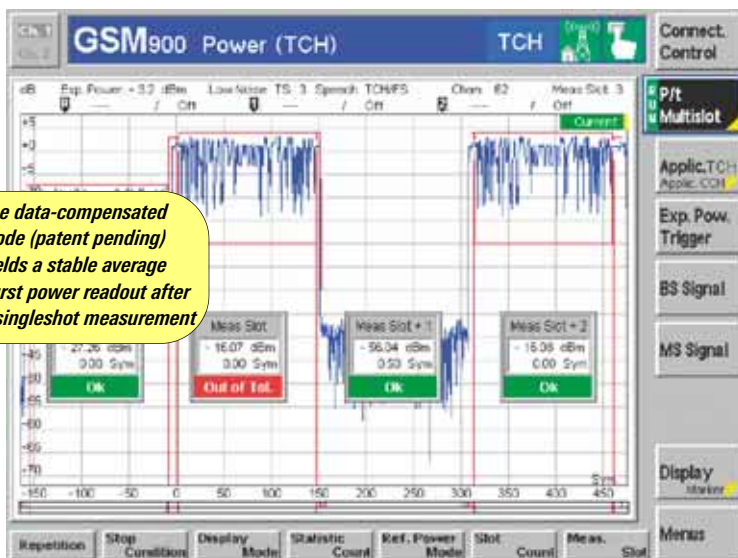

The power-versus-time multislot application can graphically display up to 4 adjacent timeslots, automatically detects GMSK- and 8PSK-modulated signals and activates the associated templates in realtime. A new zoom function allows full-screen display on each slot.

GSM/EDGE highlights of the R&S CMU300

Synchronization to BTS

- ◆ Via BTS multiframe trigger
- ◆ Via RF synchronization procedure to CCH

Activation of channel to be measured

- ◆ Without call procedure
- ◆ Simulation of mobile station including location update and MOC/MTC call procedures

GMSK/8PSK measurements

- ◆ Phase/frequency error (GMSK)
- ◆ EVM including magnitude error, origin offset, I/Q imbalance (8PSK)
- ◆ Power versus time
- ◆ Power versus slot (GMSK)
- ◆ Peak power/average burst power
- ◆ General spectrum measurements
- ◆ RAW BER, BER, RBER/FER measurements on circuit-switched channels
- ◆ BER/DBLER measurements on packet-switched channels

More features

- ◆ Realtime channel coding/decoding
- ◆ Timeslot-selective measurements in signalling mode
- ◆ Flexible RF interface for easy adaptation to DUT
- ◆ Hopping on packet-switched channels (PDTCH) supported
- ◆ RACH test
- ◆ Additional features for conformance testing
- ◆ Generation of UL signalling channels

Support of different BER test environments/loops

- ◆ BTS loop without channel coding
- ◆ BTS loop with channel coding
- ◆ Loop via A_{bis} interface
- ◆ R&S CMU 300 as RF loop with channel coding

3GPP FDD RX measurements

RF generator for Node B receiver tests

The options R&S CMU-B76 und R&S CMU-K76 add WCDMA generator functionality to the R&S CMU300, thus making it ideal not only for receiver measurements on GSM/EDGE base stations, but also for unprecedented receiver measurements on WCDMA base stations.

The R&S CMU300 supports all reference measurement channels (RMC) defined in the 3GPP specification TS25.141 (FDD) up to a data rate of 2 Mbit/s.

Sensitivity measurements on base station receivers

WCDMA generators are used to test receivers in base stations (Node B) as well as their modules. The bit error rate (BER) of the signal generated by the R&S CMU300 can be measured in the base station, in the connected radio network controller (RNC) or via an external analyzer.

For BER measurements, the analyzer must be synchronized to the received signals. Particularly for reference measurement channels, the transmitter must emit them in a defined format at a specific transmission time interval (TTI) at the physical layer. For this purpose, the R&S CMU300 provides the frame trigger input. After the WCDMA generator has been started, the requested channel is transmitted once the frame trigger (10/20/40/80 ms) has been received.

The base station receiver synchronizes to the RF signal of the R&S CMU300 and then calculates the BER from the deviation of the received signal from the expected PRBS. In 3GPP base station production, the BER can be measured without connection setup, thus keeping loss of time to a minimum.

Functions and operating modes

The generator parameters defined in the 3GPP specification TS25.141 (FDD) ensure standardized measurements. The WCDMA generator of the R&S CMU300

supports all data rates defined for the reference measurement channels, i.e. 12.2/64 / 144 / 384 / 2048 kbit/s. If one of these RMCs is selected, essential parameters for BER measurement such as coding, slot format or time transmission interval are defined. Moreover, the user can also set customized channel combinations. In addition to the RMC mode, the WCDMA generator supports the physical channel mode. In this case, the generator creates one dedicated physical control channel (DPCCH) and up to six data channels (DPDCH). The associated data rates can be flexibly selected in the range 1×15 kbit/s to 6×960 kbit/s. The test data is applied at the transport channel layer either to the reference measurement channels or directly to the physical channels. Pseudo-random bit sequences PRBS 9 / 11 / 15 and 16 as well as fixed data (00000..., 11111..., 010101...) are available as test data. The signal power in particular can be set in almost any manner designed for BER measurements. The user is able to set the total power as well as the power of the control channel and

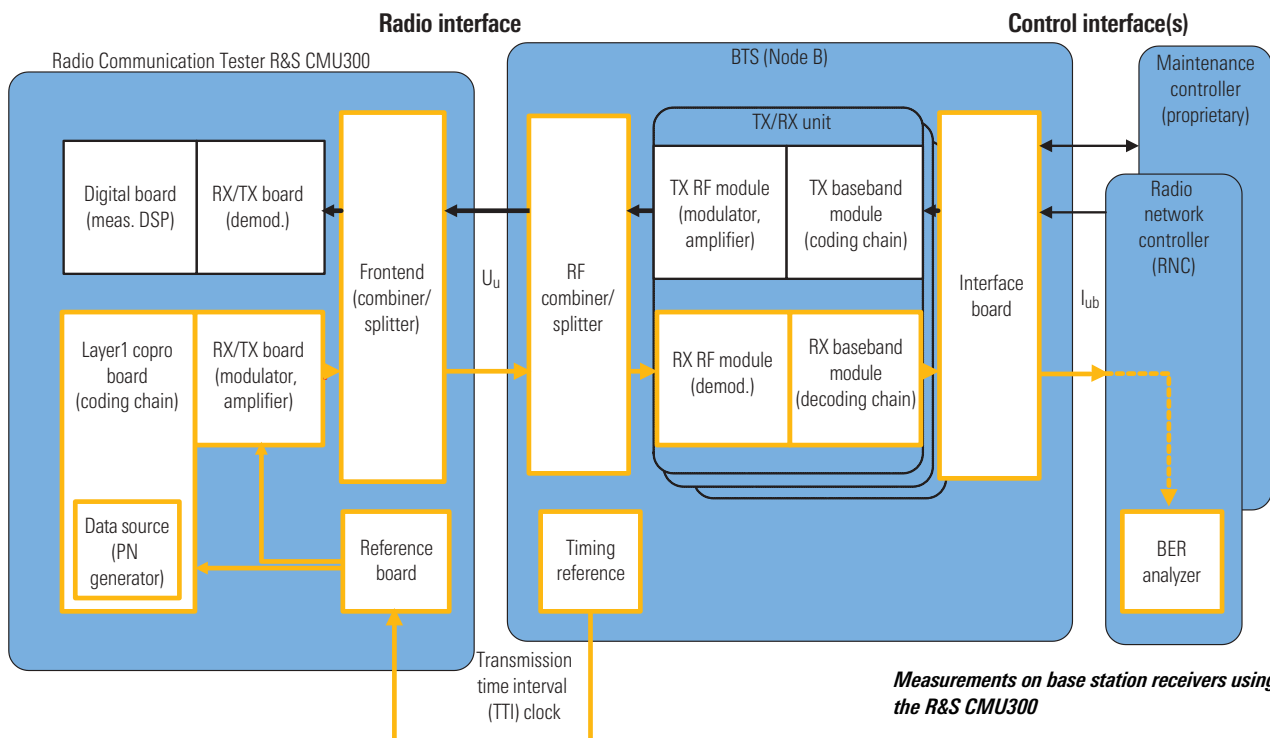

Measurements on base station receivers using the R&S CMU300

the power ratio of the DPCCCH and the DPDCH. The R&S CMU300 offers a wide variety of further settings which by far exceed the RMCs defined by 3GPP. At the physical layer, the TFCI code word and the TPC bit pattern can be varied. If channel coding has been activated, the generator calculates the TFCI code word with the associated TFCI bits. These settings allow the control of a base station receiver via the uplink signal.

The base station receiver receives the TPC bits and controls the power according to the selected downlink power control mode.

At the transmitter end, the R&S CMU300 supports power control modes 1 and 2. In mode 1, the transmit power of the generator changes in every alternating slot, increasing or decreasing by 1 dB or 2 dB. In mode 2, transmit power is constant.

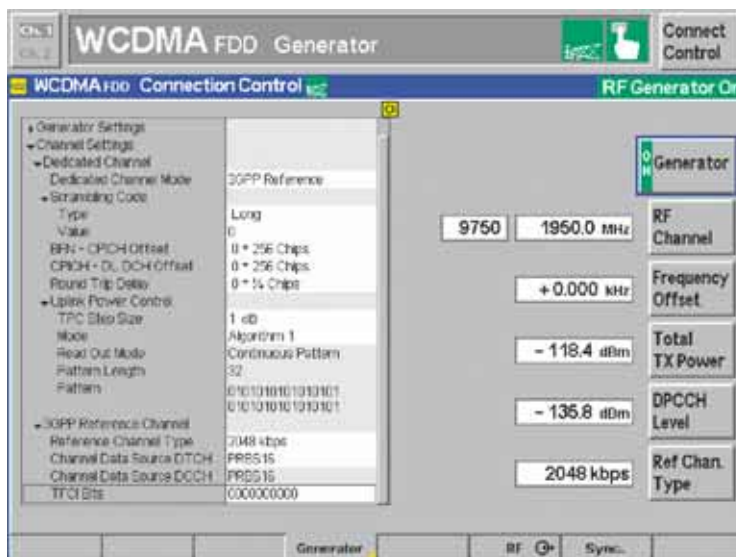

Generator menu of the R&S CMU300 in the reference channel mode with selected 2 Mbit/s channel

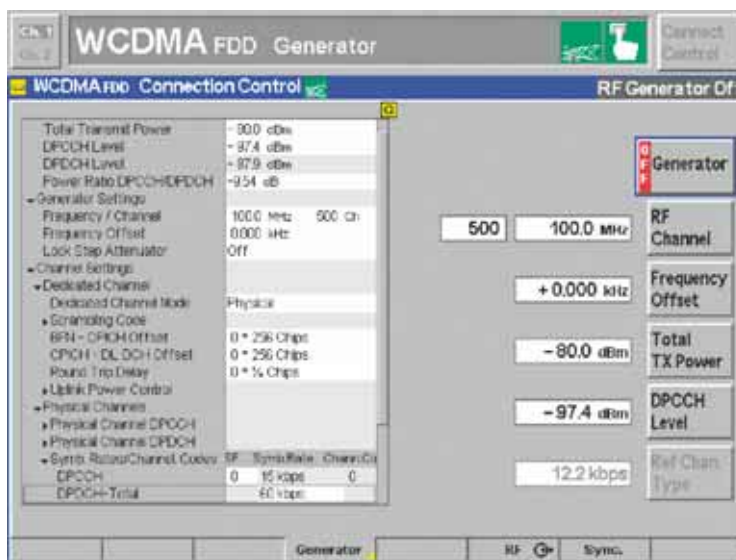

Generator setup menu of the R&S CMU300 with set physical channel mode

3GPP FDD TX measurements

Node B transmitter measurements

By means of the options R&S CMU-U75 and R&S CMU-K75, the R&S CMU300 is able to test the main transmission parameters of WCDMA base stations (Node Bs). The test models used are based on the 3GPP test specification TS25.141 FDD. However, the instrument is not limited to the test model specified for a given measurement, i.e. any test model can be selected for any measurement. For example, channel model 1.64, which contains 64 active dedicated channels (DCH), can be used for modulation measurements, although it was primarily designed for spectrum measurements. The time-consuming reconfiguration of the BTS can be omitted with some applications because all parameters can be measured with the same test model.

Code domain power (CDP)

Precise power control in uplink and downlink is essential in CDMA systems. The CDP measurement analyzes power distribution across the individual code channels by recording and measuring a complete WCDMA frame for each measurement cycle. The screen is divided into three sections to handle the complex signal structure.

In the top section, the CDP is displayed as a function of all codes. Active code channels are colour-highlighted and combined to form a bar whose width depends on the spreading factor.

In the center section, the CDP of a selected code is displayed as a function of time. Since the individual code channels may be time-delayed with respect to the frame start, the center diagram contains two time scales. The common pilot channel (CPICH) is used as a reference for

the different measurement results because it is not time-delayed (displayed on the first scale). A second scale refers to the selected code channel.

In the lower section, the CDP and other measurands are displayed as scalar values referring to the selected CPICH slot. This yields an overview of the behaviour of important parameters. Toggling between the individual test menus is thus not necessary.

Code domain error power (CDEP)

The CDEP is an analysis of the error signal in the code domain, i.e. the projection of the error power onto the individual code channels. As with the CDP measurement, the screen is divided into three sections. The CDEP is to be measured across a CPICH slot with a defined spreading factor.

The top diagram displays the CDEP as a function of all codes in the selected CPICH slot. In the center diagram, the peak code domain error power (PCDEP) is displayed as a function of all 15 frame slots. Here, too, comprehensive means for analysis are available. For example, if there is a particularly high PCDEP in a slot, the CDEP as a function of all codes can be viewed by selecting this slot, and thus the code channel with the maximum error can be detected.

Error vector magnitude (EVM)

In the time domain, the EVM is equivalent to the CDEP in the code domain. The EVM is the difference between the ideal reference signal and the processed test signal. In contrast to the CDEP, the error is analyzed at the chip level, so that errors are shown as a function of time on the basis of the chip offset from the selected CPICH slot. Analysis is again frame-based; therefore all RMS values of the individual slots are also displayed as a function of time.

Occupied bandwidth (OBW), spectrum emission mask (SEM) and adjacent channel leakage ratio (ACLR)

OBW, SEM and ACLR are important additional measurements for the spectral analysis of a WCDMA transmitter. The R&S CMU300 conveniently provides them as "single key" measurements.

Multicarrier operation

Today's base stations are increasingly implementing multicarrier operation. The R&S CMU300 can perform measurements in real multicarrier environments; up to four carriers running simultaneously on a base station will have minimal effects on the measurement results.

Innovative R&S CMU300:

- ◆ Compact radio test set featuring GSM/GPRS/EDGE and WCDMA standards in one unit
- ◆ Existing GSM/EDGE instruments easily upgradeable to WCDMA
- ◆ Clear and easy-to-operate user interface

WCDMA receiver tests

- ◆ Provision of all uplink reference channels from 12.2 kbps to 2048 kbps
- ◆ Signal generation in realtime with test data lengths up to PRBS 16 for continuous receiver measurements
- ◆ Extremely fast response to newly entered parameters if the RF signal is active

WCDMA transmitter measurements

- ◆ Comprehensive high-speed power, modulation and spectrum measurements

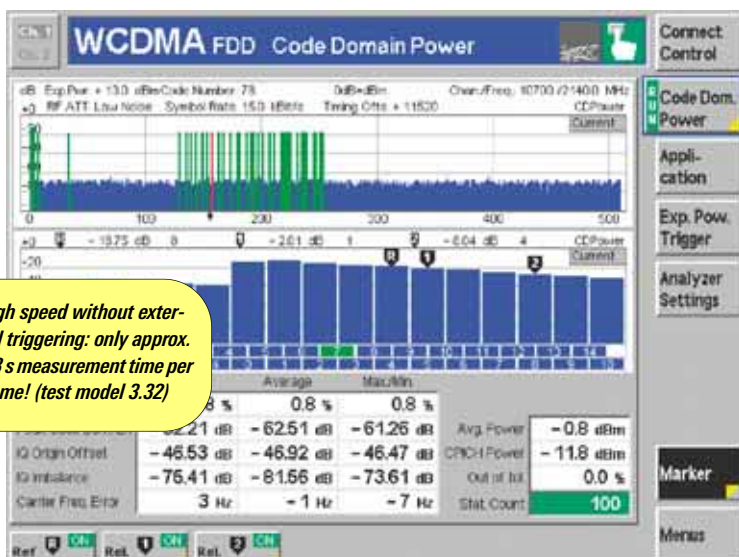

Code domain power measurement with test model 3.32

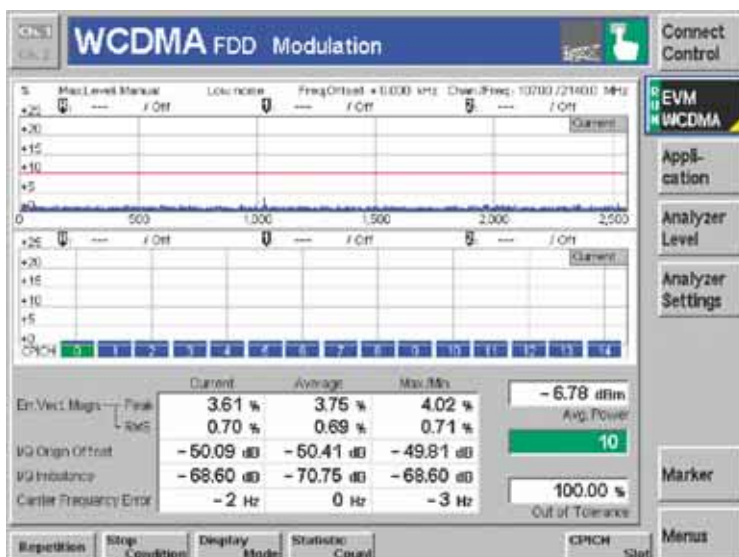

Error vector magnitude measurement

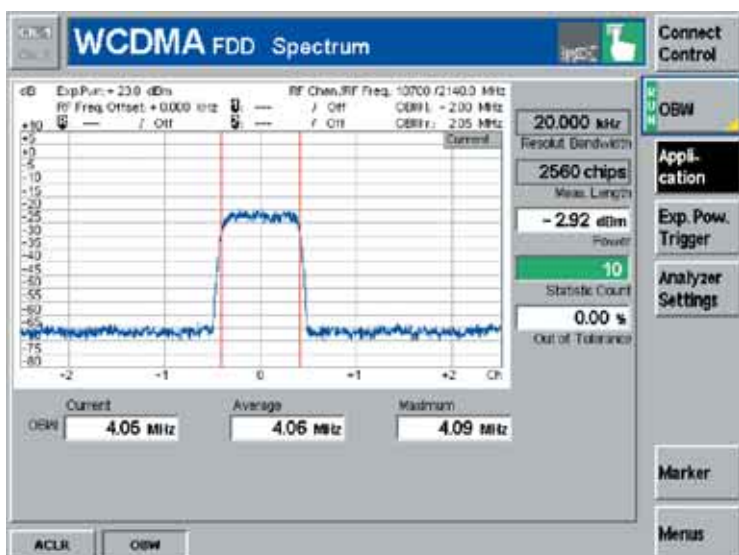

Occupied bandwidth measurement

I/Q and IF interfaces for the R&S CMU300

Functionality

The option R&S CMU-B17 allows access to analog I/Q and IF signals in both communication directions (uplink and downlink). Once a radio link has been established, complex I/Q signals can be applied or transmitted for further analysis. This solution will allow the R&S CMU300 to be used for new tasks in the development and testing of base stations and their modules.

Technical concept

The selectable I/Q and IF interface module is looped between the RF module (modulator, demodulator) and the digital module (test DSP, signalling unit) of the R&S CMU300. During normal operation without access to I/Q or IF signals, the interface module can be set to the bypass mode. This eliminates any further influence on the transmit and receive signal, and the original data of the instrument is retained. In addition to preconfigured default settings for constantly recurring T&M tasks (e.g. fading of the transmit signal), all types of customized signal path combinations can be set.

Receiver tests under fading conditions

A fading simulator is used to test the receiver characteristics of base stations under practical conditions. An RF channel that is ideal if the tester and the DUT are connected by means of a cable is provided with fading effects that also occur under real field conditions.

Fitted with the option R&S CMU-B17, the R&S CMU300, together with the Fading Simulator R&S ABFS, provides a cost-effective solution for the specified measurement task. Optionally, the Signal Generator R&S SMIQ with the option R&S SMIQB14 can be used; the transmit module of the generator can also provide a faded RF signal.

Testing of mobile radio modules

Another major application is the generation and analysis of I/Q signals. Most mobile radio modules include an RF module and a baseband module that communicate with each other via an analog I/Q interface. The I/Q and IF interface can now be used to access the RF modules from both sides.

Quite often, different teams in the development departments are responsible for the RF and the baseband modules. Testing via the I/Q interfaces allows space- and time-independent development work.

I/Q signal analysis

If I/Q signals are applied to the receive path of the R&S CMU300, they can be analyzed analogously to the RF signals. In addition to more complex modulation parameters (error vector magnitude (EVM), peak code domain error power), direct I/Q parameters such as I/Q offset or I/Q imbalance can be analyzed.

Your local Rohde & Schwarz representative will gladly provide you with further information about the option R&S CMU-B17.

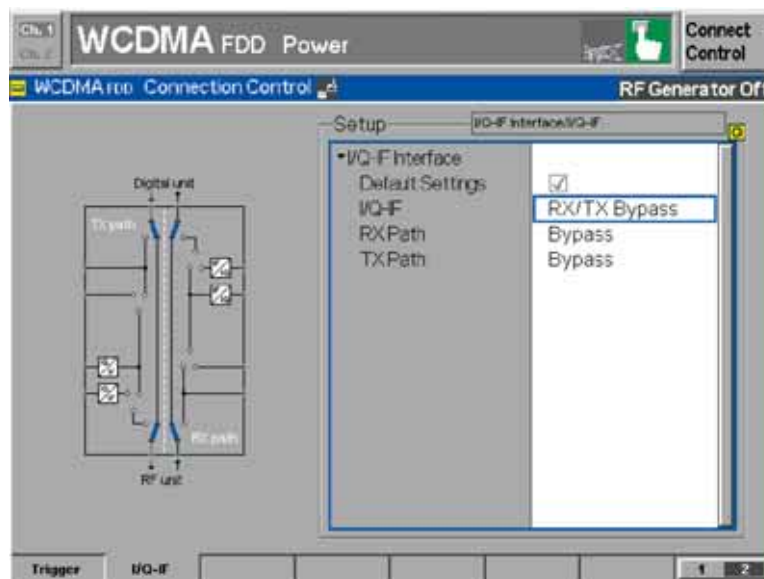

Menu in the R&S CMU300 for setting the test paths (default setting: RX/TX bypass mode)

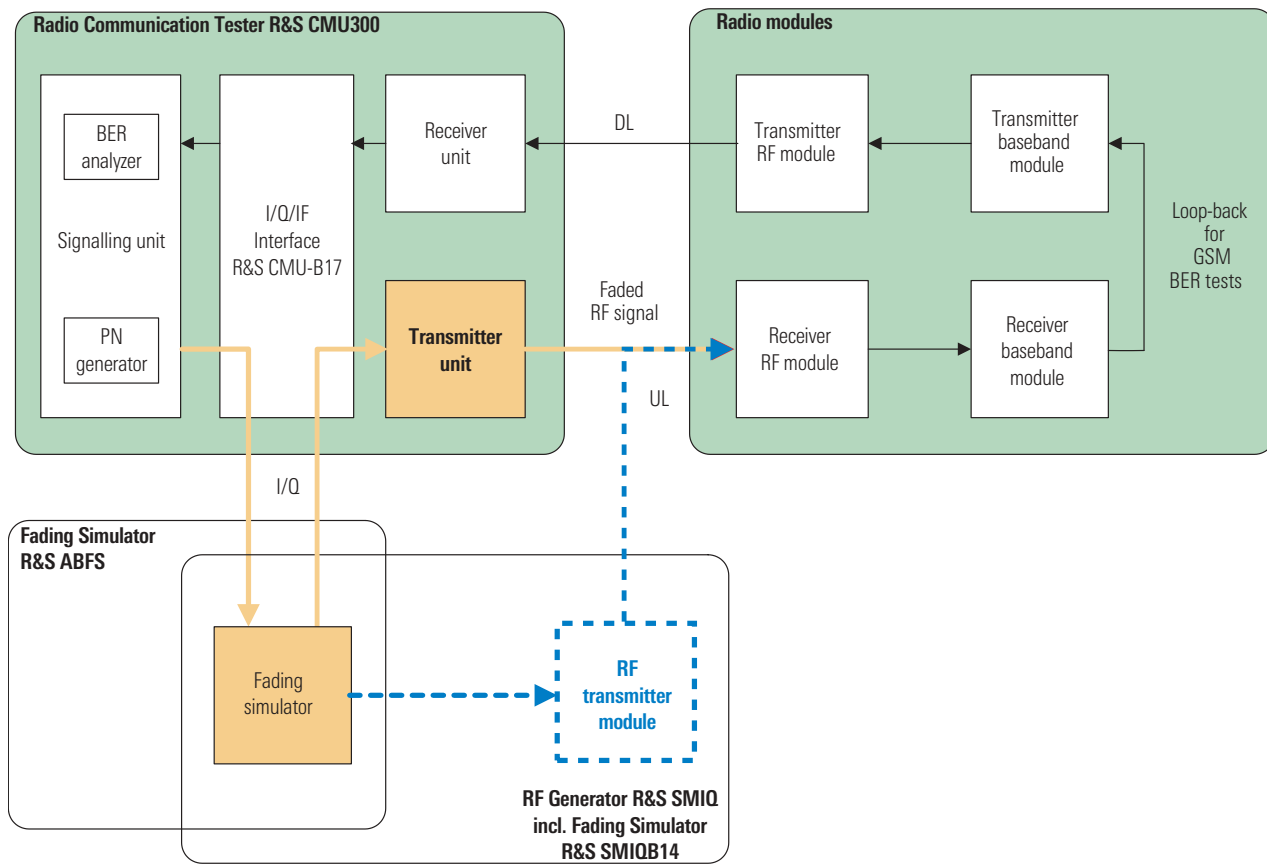

Test setup for receiver tests under fading conditions

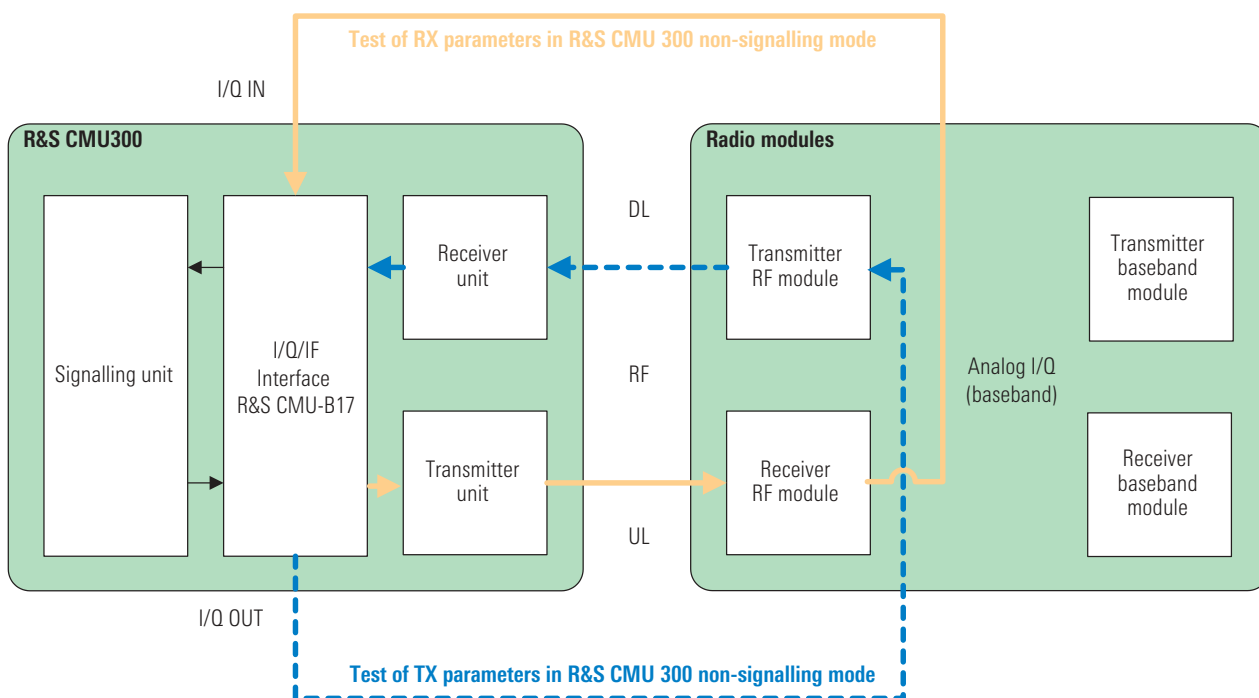

Signal paths when testing RF modules

Models and options

Instruments, options and ordering information

Type/Option	Description	BERT GSM	BERT GPRS	BERT EGPRS	GMSK TX tests	8PSK TX tests	FDD UL generator	FDD DL TX test	Order No.
R&S CMU300	Universal Radio Communication Tester for BTS Test	✓	✓	✓	✓	✓	✓	✓	1100.0008.03
R&S CMU-B12	HW option: reference oscillator OCXO, aging 3.5×10^{-8} /year	☺	☺	☺	☺	☺	–	–	1100.5100.02
R&S CMU-B17	HW option: IQ/IF interface, analog, one channel, (R&S CMU300 factory installation only)	☺	☺	☺	☺	☺	☺	☺	1100.6906.02
R&S CMU-B21 Var 02	HW option: versatile signalling unit for R&S CMU	✓	✓	✓	✓	✓	–	–	1100.5200.02
R&S CMU-B71	HW option: A _{bis} interface unit; E1/T1 protocol; for BER test only	☺	–	–	–	–	–	–	1100.6406.02
R&S CMU-B76	HW option: layer1 board for WCDMA	–	–	–	–	–	✓	–	1150.0601.02
R&S CMU-K30	SW option: GSM400 BTS measurement software, R&S CMU-B21 required	✓ ¹⁾	✓ ¹⁾	✓ ¹⁾	✓ ¹⁾	✓ ¹⁾	–	–	1115.4004.02
R&S CMU-K31	SW option: GSM900 BTS measurement software, R&S CMU-B21 required	✓ ¹⁾	✓ ¹⁾	✓ ¹⁾	✓ ¹⁾	✓ ¹⁾	–	–	1115.4104.02
R&S CMU-K32	SW option: GSM1800 BTS measurement software, R&S CMU-B21 required	✓ ¹⁾	✓ ¹⁾	✓ ¹⁾	✓ ¹⁾	✓ ¹⁾	–	–	1115.4204.02
R&S CMU-K33	SW option: GSM1900 BTS measurement software, R&S CMU-B21 required	✓ ¹⁾	✓ ¹⁾	✓ ¹⁾	✓ ¹⁾	✓ ¹⁾	–	–	1115.4304.02
R&S CMU-K34	SW option: GSM850 BTS measurement software, R&S CMU-B21 required	✓ ¹⁾	✓ ¹⁾	✓ ¹⁾	✓ ¹⁾	✓ ¹⁾	–	–	1115.4404.02
R&S CMU-K38	SW option: signalling channels (GSM/UL) with PSRB pattern modulation, R&S CMU-K30 to K33 required	☺	–	–	–	–	–	–	1150.3400.02
R&S CMU-K39	SW option: GSM signalling procedure MOC/MTC (circuit-switched), R&S CMU-K30 to K33 required	☺	–	–	☺	☺	–	–	1115.4791.02
R&S CMU-K41	SW option: EDGE/8PSK extension for GSM Hardware/Software (8PSK TX tests and EGPRS channel coders), R&S CMU-K30 to K33 required	–	–	✓	–	✓	–	–	1115.4504.02
R&S CMU-K75	SW option: WCDMA TX test (3GPP FDD/DL), R&S CMU-U75 required	–	–	–	–	–	–	✓	1150.3200.02
R&S CMU-K76	SW option: WCDMA generator (3GPP FDD/UL), R&S CMU-B76 required	–	–	–	–	–	✓	–	1150.3300.02
R&S CMU-U10	HW modification: memory extension for 64 MByte CMU	☺	☺	☺	☺	☺	☺	☺	1159.0404.02
R&S CMU-U74	Upgrade kit for units delivered before July 2003: high dynamic WCDMA spectrum measurements	–	–	–	–	–	–	☺	1159.0704.02
R&S CMU-U75	Upgrade kit: measurement DSP module for WCDMA	–	–	–	–	–	–	✓	1150.0501.02
R&S CMU-U76	Upgrade kit: layer 1 board for WCDMA (to be used for upgrade of existing units instead of R&S CMU-B76)	–	–	–	–	–	☺	–	1150.0701.02
R&S CMU-DCV	Documentation of calibration values	☺	☺	☺	☺	☺	☺	☺	0240.2193.08
R&S CMU-DKD	R&S CMU200/300 DKD calibration incl. ISO9000 calibration (order only with device)	☺	☺	☺	☺	☺	☺	☺	1159.4600.02
R&S CMU-Z1	Accessory: 256 Mbyte memory card, PCMCIA type 3	☺	☺	☺	☺	☺	☺	☺	1100.7490.04
R&S CMU-Z6	Accessory: enhancement of wideband modulation analysis	–	–	–	–	–	–	☺	1150.0001.02
R&S PSM-B9	PCMCIA type 3, 520 Mbyte hard disk	☺	☺	☺	☺	☺	☺	☺	1064.5700.02
R&S ZAA-411	19" rack adapter	☺	☺	☺	☺	☺	☺	☺	1096.3283.00

Comments on table:

- ✓ mandatory; ☺ optional; – not applicable
¹⁾ Depending on the required frequency band.

For specifications please refer to document PD 0758.0000.22, version ≥ 1.00



ROHDE & SCHWARZ